

1 2 3 4 5 6 7 8 9 0

A B C D E F G H

A B C D E F G H

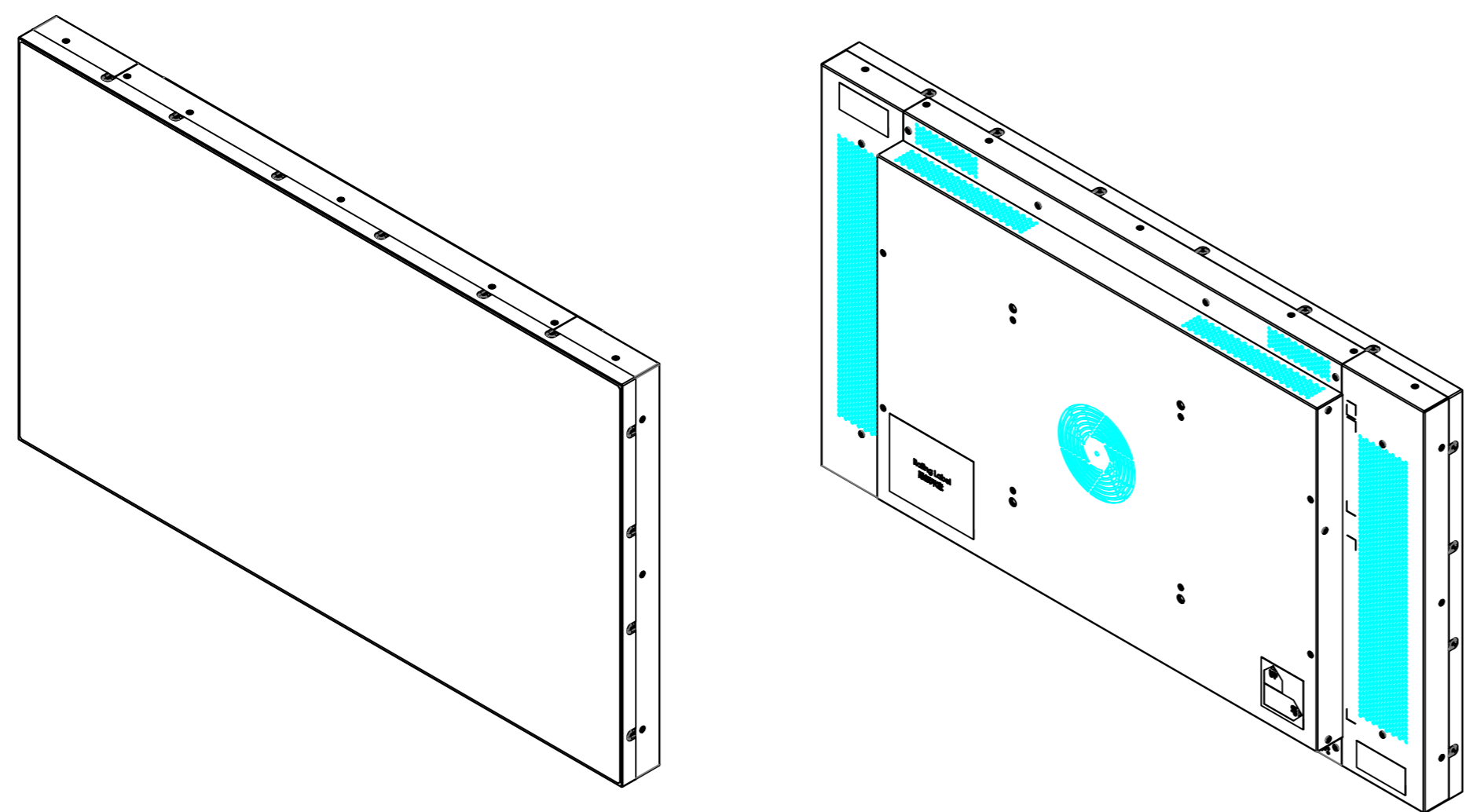
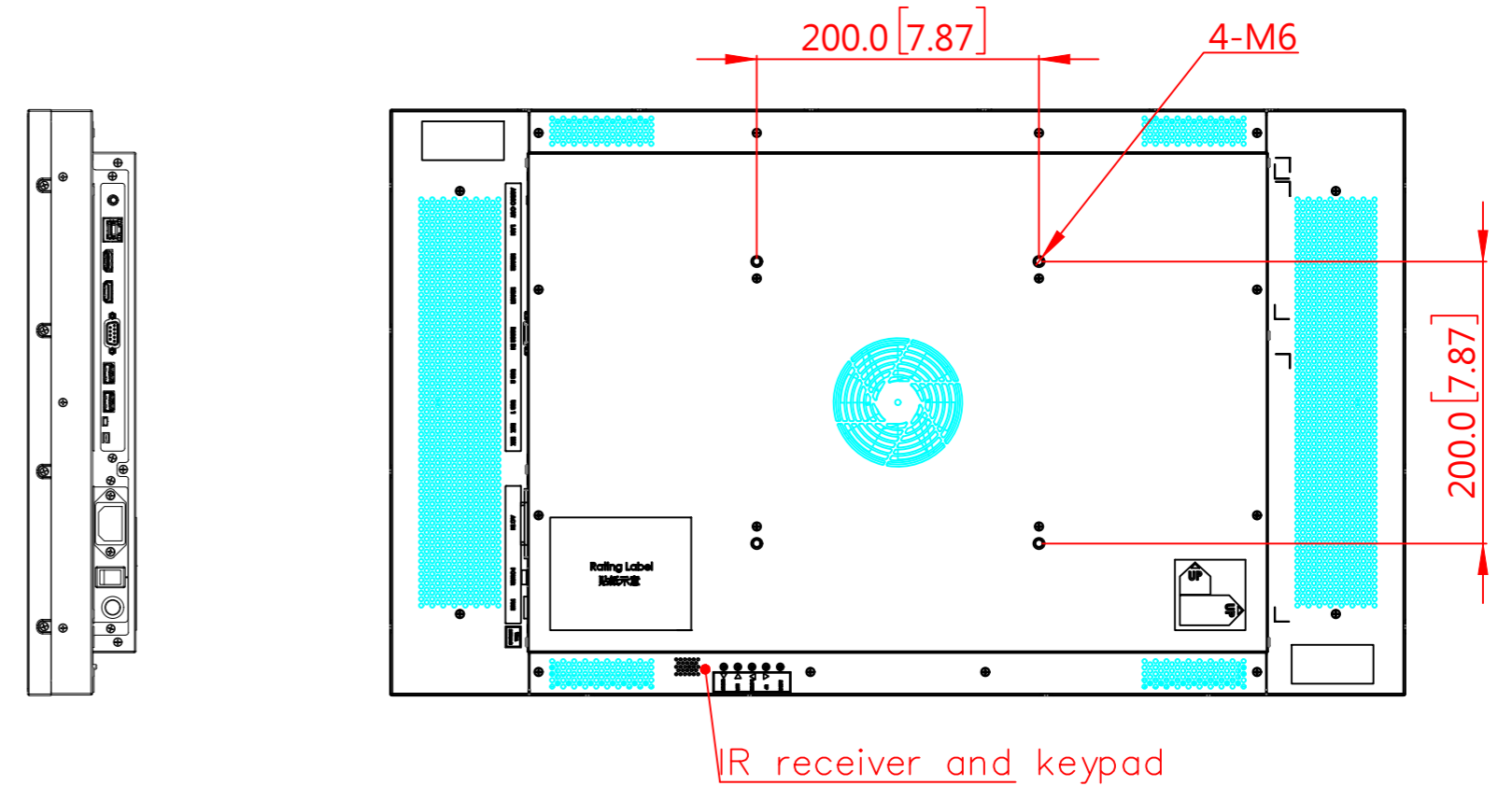
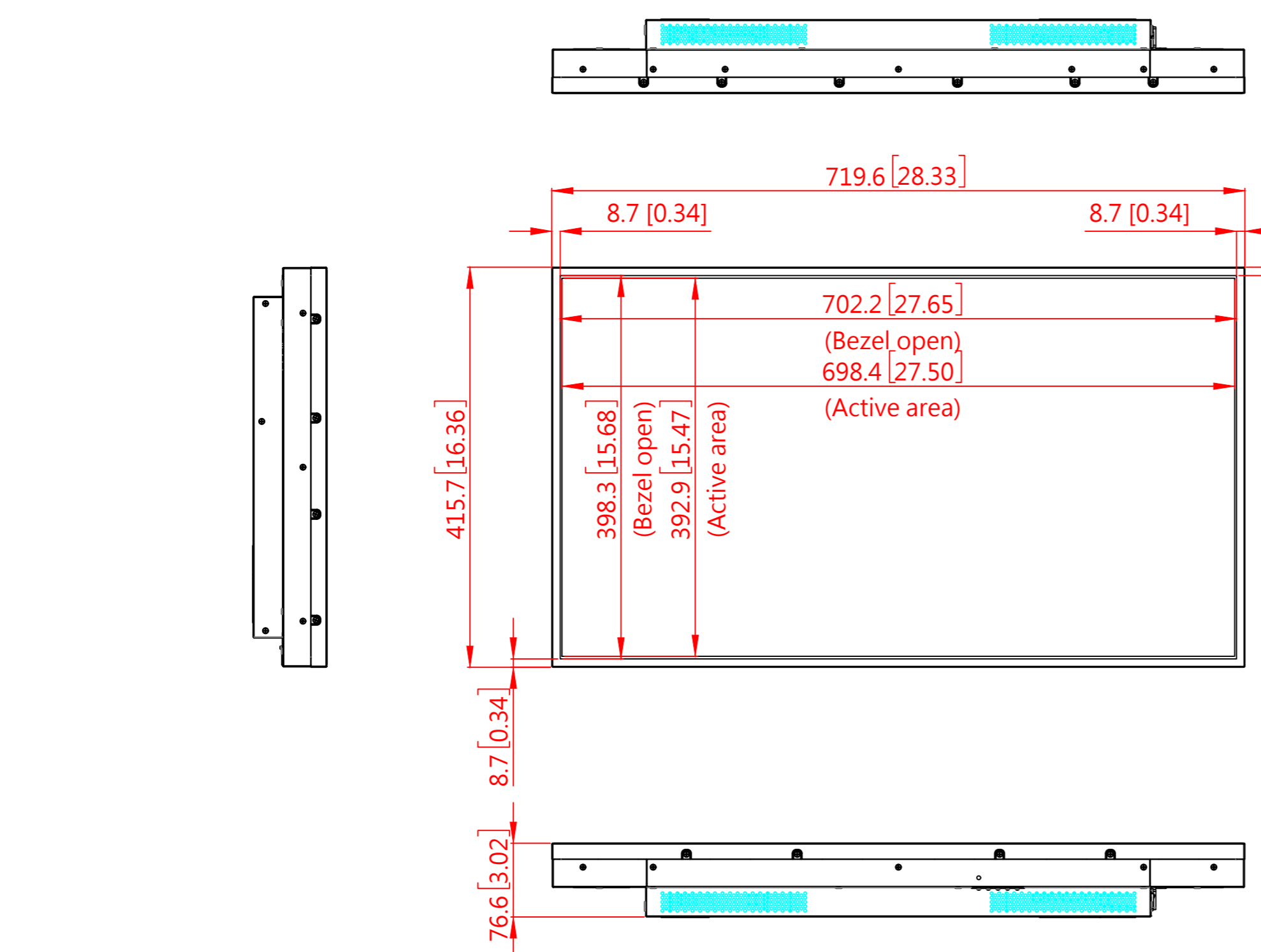

Unit	UNLESS OTHERWISE SHOWN TOLERANCES	MODEL NAME
mm/in	.X ± 1.5/0.05 X. ± 2.0	DS323LT4_J1.0
DynaScan Technology Corp.		DATE
		2022.02.21